

ULH-10671

Lightsoft 15 Bollard

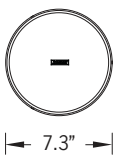

[Top] 27w LED 1188 Lumens
 [Accent Light] 12w LED 1080 Lumens
 IP65 · Suitable For Wet Locations
 IK10 · Impact Resistant (Vandal Resistant)
 Weight 23 lbs

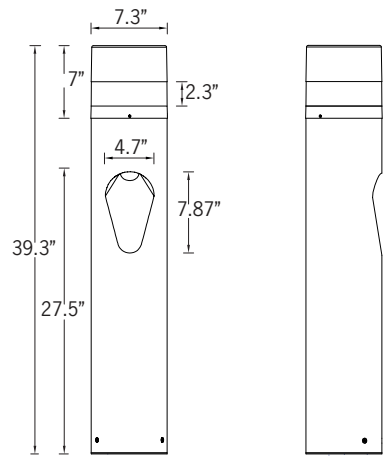

Top View

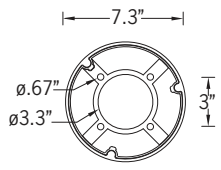

Mounting Detail

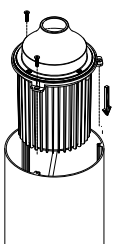

IP65 - Internal top access driver housing, prewired with SO cord and waterproof cable gland for easy installation.

Construction

Aluminum
 Less than 0.1% copper content – Marine Grade 6060 extruded & LM6 Aluminum High Pressure die casting provides excellent mechanical strength, clean detailed product lines and excellent heat dissipation.

Pre-paint
 8 step degrease and phosphate process that includes deoxidizing and etching as well as a zinc and nickel phosphate process before product painting.

Memory Retentive -Silicon Gasket
 Provided with special injection molded "fit for purpose" long life high temperature memory retentive silicon gaskets. Maintains the gaskets exact profile and seal over years of use and compression.

Thermal management
 LM6 Aluminum is used for its excellent mechanical strength and thermal dissipation properties in low and high ambient temperatures. The superior thermal heat sink design by Ligman used in conjunction with the driver, controls thermals below critical temperature range to ensure maximum luminous flux output, as well as providing long LED service life and ensuring less than 10% lumen depreciation at 50,000 hours.

Surge Suppression
 Standard 10kv surge suppressor provided with all fixtures.

BUG Rating
 B1 - U3 - G1

Finishing
 All Ligman products go through an extensive finishing process that includes fettling to improve paint adherence.

Paint
 UV Stabilized 4.9Mil thick powder coat paint and baked at 200 Deg C. This process ensures that Ligman products can withstand harsh environments. Rated for use in natatoriums.

MicroPRIM Finishes
 MicroPRIM is Ligman's trade marked decorative powder coating technology that permanently infuses colors, patterns, or imagery directly into the surface of luminaires and poles while providing protections that standard powder coating does not offer.

MicroPRIM finishes include nature-inspired wood grains and stone aesthetics, material-inspired finishes such as brushed metal, concrete, and carbon fiber, Solid colors in Ligman standard colors, as well as any RAL or Pantone color, Decorative patterns, custom imagery and more.

Coating and Infusion Process

Metal components are pre-treated and powder coated with a proprietary polyurethane-based coating engineered for outdoor architectural use. Decorative patterns or imagery are then permanently infused into the cured powder coat through a heat-based process, creating a durable, integrated finish.

Performance and Validation

MicroPRIM finishes are suitable for indoor and outdoor applications and meet AAMA2605 architectural coating requirements. Performance is validated through laboratory and real-world testing to ASTM standards for UV exposure, adhesion, abrasion, impact, salt spray, chemical resistance, and graffiti resistance.

All MicroPRIM finishes are backed by Ligman's 10-year warranty.

Key Performance Attributes
 •Anti-graffiti resistance
 •UV and weather resistance
 •Scratch and abrasion resistance
 •Natatorium Rated for installation in corrosive environments

Hardware
 Provided Hardware is Marine grade 316 Stainless steel.

Anti Seize Screw Holes
 Tapped holes are infused with a special anti seize compound designed to prevent seizure of threaded connections, due to electrolysis from heat, corrosive atmospheres and moisture.

Crystal Clear Low Iron Glass Lens
 Provided with tempered, impact resistant crystal clear low iron glass ensuring no green glass tinge.

Optics & LED
 Precise optic design provides exceptional light control and precise distribution of light.
 LED CRI > 80

Lumen - Maintenance Life
 L80 /B10 at 50,000 hours (This means that at least 90% of the LED still achieve 80% of their original flux)

Indirect light-emitting bollard with integrated accent light.

The innovative reflector technology of the Lightsoft bollard guarantees a high degree of efficiency and optimal visual comfort. Lightsoft has been developed to have excellent controlled downward light providing wide spacing ratios. It has three light shield accessories with different light distributions. The Lightsoft is available in a cylindrical or square shape design with two different heights.

The Lightsoft Bollard comes standard with a unique waterproof internal driver housing compartment that is situated at the top of the pole to stop water and dust from entering the electrical components. This fixture is supplied completely wired with powercord and waterproof gland from the driver enclosure to the base of the bollard ensuring quick trouble-free installation. Custom bollard heights are available, please specify.

Color temperature 2700K, 3000K, 3500K and 4000K. Custom wattages can be provided to suit customer and Title 24 requirements. (Specify total watts per fixture)

All Ligman fixtures can be manufactured using a special pre-treatment and coating process that ensures the fixture can be installed in natatoriums as well as environments with high concentrations of chlorine or salt and still maintain Ligman's 10-year warranty. For this natatorium rated process please specify NAT in options.

This product is provided with an integrated 12w recessed accent light that can be used for providing low glare illumination and additional light on pathways, as well as providing backlight to accent foliage or landscape elements.

This 12w recessed accent light is available with narrow, medium and wide beam spreads.

Additional Options (Consult Factory For Pricing)

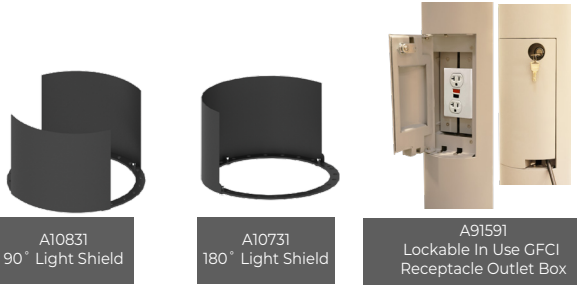

PROJECT		DATE	
---------	--	------	--

QUANTITY		TYPE		NOTE	
----------	--	------	--	------	--

ORDERING EXAMPLE || ULH - 10671 - 27/12w - W - W30 - 02 - 120/277v - Options

ULH-10671					
LAMP	BEAM	LED COLOR	FINISH COLOR	VOLTAGE	
[Top] 27w LED 1188 Lumens	ACCENT LIGHT BEAM N - Narrow 16° M - Medium 27° W - Wide 43°	W27 - 2700K W30 - 3000K W35 - 3500K W40 - 4000K AMB - TURTLE FRIENDLY Amber LED	01 - BLACK RAL 9011 02 - DARK GREY RAL 7043 03 - WHITE RAL 9003 04 - METALLIC SILVER RAL 9006 05 - MATTE SILVER RAL 9006 06 - LIGMAN BRONZE 07 - CUSTOM RAL	120/277v	
[Accent Light] 12w LED 1080 Lumens					

--	--	--

ADDITIONAL OPTIONS

- A10731 - 180° Light Shield
- A10831 - 90° Light Shield
- GFCI - GFCI Box
- NAT - Natatorium Rated
- DIM - 0-10v Dimming
- A91591 - Lockable In Use GFCI Receptacle Outlet Box
- HGT - Custom Bollard Height [Specify HGT=XX"]
- A14291 - Remote Controller for Motion Sensor
- UL - Non-Illuminated (Unlit Bollard)

CITY OF FLAGSTAFF & TURTLE FRIENDLY COMPLIANT

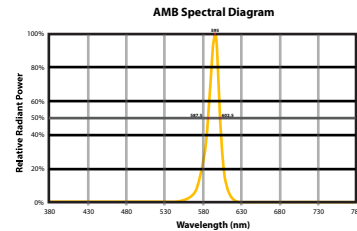

Narrow-Spectrum Amber LEDs
Peak wavelength between 585 & 595 nanometers and a full width of 50% power no greater than 15 nanometers.

More Custom Finishes Available Upon Request

Consult factory for pricing and lead times

THERE IS AN ADDITIONAL COST FOR THESE FINISHES

MicroPRIM FINISHES

- SW01 - OAK FINISH
- SW02 - WALNUT FINISH
- SW03 - PINE FINISH
- DF - DOUGLAS FIR FINISH
- CW - CHERRY WOOD FINISH
- NW - NATIONAL WALNUT FINISH
- SU01 - CONCRETE FINISH
- SU02 - SOFTSCAPE FINISH
- SU03 - STONE FINISH
- SU04 - CORTEN FINISH
- CSM - Custom Image/Pattern

MicroPRIM FINISHES

- MP - MAPLE FINISH
- MHG - MAHOGANY FINISH
- BH - BEECH FINISH
- CN - CHESTNUT FINISH
- WMBL - WHITE MARBLE FINISH
- MBL - MARBLE FINISH
- GRNT - GRANITE FINISH
- BGD - BRUSHED GOLD FINISH
- BBRZ - BRUSHED BRONZE FINISH
- CAMO - CAMOUFLAGE FINISH

- MP01 - MicroPRIM RAL 9011 Black (Glossy)
- MP02 - MicroPRIM RAL 7043 Dark Grey (Glossy)
- MP03 - MicroPRIM RAL 9003 White (Glossy)
- MP04 - MicroPRIM RAL 9006 Metallic Silver (Glossy)
- MP05 - MicroPRIM RAL 9006 Matte Silver (Matte/Textured)
- MP06 - MicroPRIM Ligman Bronze (Glossy)
- MP07 - MicroPRIM Custom Color (Glossy)

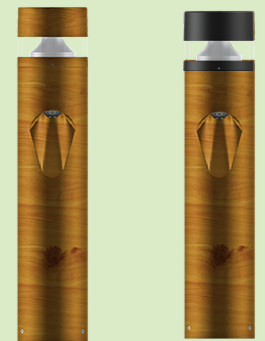

MicroPRIM Finish + Two-Tone Style

