



20w LED
2422 Lumens

IP65
Suitable for wet locations

IK08
Impact Resistant [Vandal Resistant]

Weight - 23 lbs

Construction

Aluminum
Less than 0.1% copper content - Marine Grade 6060 extruded & LM6 Aluminum High Pressure die casting provides excellent mechanical strength, clean detailed product lines and excellent heat dissipation.

Pre_paint
8 step degrease and phosphate process that includes deoxidizing and etching as well as a zinc and nickel phosphate process before product painting.

Memory Retentive -Silicon Gasket
Provided with special injection molded "fit for purpose" long life high temperature memory retentive silicon gaskets. Maintains the gaskets exact profile and seal over years of use and compression.

Thermal management
LM6 Aluminum is used for its excellent mechanical strength and thermal dissipation properties in low and high ambient temperatures. The superior thermal heat sink design by Ligman used in conjunction with the driver, controls thermals below critical temperature range to ensure maximum luminous flux output, as well as providing long LED service life and ensuring less than 10% lumen depreciation at 50,000 hours.

Surge Suppression
Standard 10kv surge suppressor provided with all fixtures.

BUG Rating
B1 - U0 - G1

Finishing
All Ligman products go through an extensive finishing process that includes fettling to improve paint adherence.

Paint
UV Stabilized 4.9Mil thick powder coat paint and baked at 200 Deg C. This process ensures that Ligman products can withstand harsh environments. Rated for use in natatoriums.

MicroPRIM Finishes
MicroPRIM is Ligman's trade marked decorative powder coating technology that permanently infuses colors, patterns, or imagery directly into the surface of luminaires and poles while providing protections that standard powder coating does not offer.

MicroPRIM finishes include nature-inspired wood grains and stone aesthetics, material-inspired finishes such as brushed metal, concrete, and carbon fiber, Solid colors in Ligman standard colors, as well as any RAL or Pantone color, Decorative patterns, custom imagery and more.

Coating and Infusion Process

Metal components are pre-treated and powder coated with a proprietary polyurethane-based coating engineered for outdoor architectural use. Decorative patterns or imagery are then permanently infused into the cured powder coat through a heat-based process, creating a durable, integrated finish.

Performance and Validation

MicroPRIM finishes are suitable for indoor and outdoor applications and meet AAMA2605 architectural coating requirements. Performance is validated through laboratory and real-world testing to ASTM standards for UV exposure, adhesion, abrasion, impact, salt spray, chemical resistance, and graffiti resistance.

All MicroPRIM finishes are backed by Ligman's 10-year warranty.

Key Performance Attributes

- Anti-graffiti resistance
- UV and weather resistance
- Scratch and abrasion resistance
- Natatorium Rated for installation in corrosive environments)

Hardware
Provided Hardware is Marine grade 316 Stainless steel.

Anti Seize Screw Holes
Tapped holes are infused with a special anti seize compound designed to prevent seizure of threaded connections, due to electrolysis from heat, corrosive atmospheres and moisture.

Crystal Clear Low Iron Glass Lens
Provided with tempered, impact resistant crystal clear low iron glass ensuring no green glass tinge.

Optics & LED
Precise optic design provides exceptional light control and precise distribution of light. LED CRI > 80

Lumen - Maintenance Life
L80 /B10 at 50,000 hours (This means that at least 90% of the LED still achieve 80% of their original flux)

A new contemporary bollard design family, meeting Dark Sky requirements, utilizing MicroVos Technology to get maximum spacing and excellent uniformity.

Small, medium and large size LED bollards incorporates optional symmetrical and asymmetrical light distributions, in a variety of different heights. Clean architectural design with no visible hardware, at the top of the luminaire are the further characteristics of this bollard. Ideal for lighting pathways, entrances, square, and terraces.

Color temperature from 2700K, 3000K, 3500K and 4000K, LED CRI >80. Aluminum housing and extruded aluminium column with high corrosion resistance. Stainless steel fasteners in grade 316. Durable silicone rubber gasket and clear toughened glass. Powder coating with high corrosion resistance and chemical chromatized protection.

To meet International Dark Sky criteria, 3000k or warmer LEDs must be selected.

CITY OF FLAGSTAFF & TURTLE FRIENDLY COMPLIANT

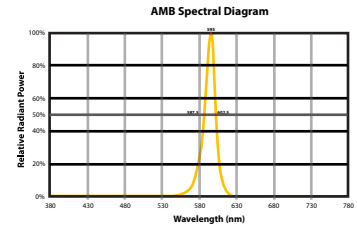

Narrow-Spectrum Amber LEDs
Peak wavelength between 585 & 595 nanometers and a full width of 50% power no greater than 15 nanometers.

Additional Options (Consult Factory For Pricing)

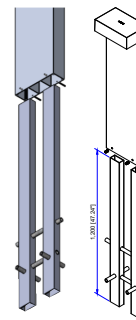

PRB
Pedestrian Rated Bollard
(Not Intended for Traffic)

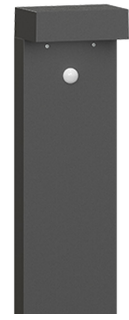

OS-
Occupancy
Sensor



A14291
Remote Control
for Occupancy Sensor

When ordering OS: Occupancy Sensor, A14291 should be ordered to program sensor

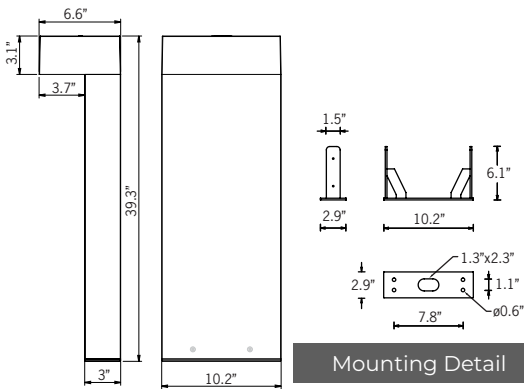

Ligman's micro Variable Optical System provides the ability to interchange, mix & rotate optics to provide specific light distributions for optimized spacing and uniformity.

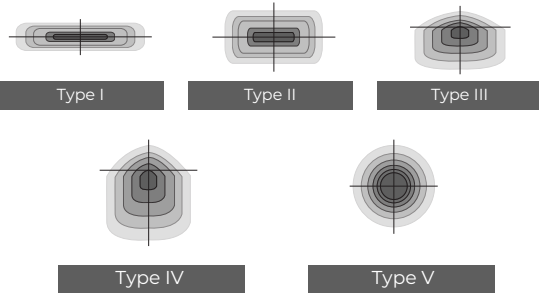

The variable optic system allows for the designer to create hybrid distributions for precise lighting requirements.

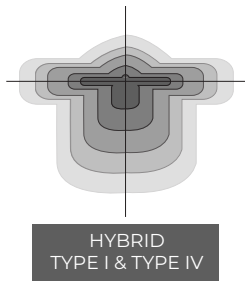

PROJECT		DATE	
---------	--	------	--

QUANTITY		TYPE		NOTE	
----------	--	------	--	------	--

ORDERING EXAMPLE || UPRA - 10022 - 20w - T2 - W30 - 02 - 120/277v - Options

UPRA-10022					
LAMP	BEAM	LED COLOR	FINISH COLOR	VOLTAGE	
20w LED 2422 Lumens	T1 - Type I Distribution T2 - Type II Distribution T3 - Type III Distribution T4 - Type IV Distribution M - Medium 32° W - Wide 52° VW - Very Wide 65° EW - Extra Wide 108°	W27 - 2700K W30 - 3000K W35 - 3500K W40 - 4000K AMB - TURTLE FRIENDLY Amber LED	01 - BLACK RAL 9011 02 - DARK GREY RAL 7043 03 - WHITE RAL 9003 04 - METALLIC SILVER RAL 9006 05 - MATTE SILVER RAL 9006 06 - LIGMAN BRONZE 07 - CUSTOM RAL		

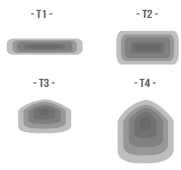

--	--	--

ADDITIONAL OPTIONS

- | | |
|--|---|
| <ul style="list-style-type: none"> NAT - Natatorium Rated HGT - Custom Bollard Height DIM - 0-10v Dimming FNF - Front Face Nature Finish | <ul style="list-style-type: none"> OS - Occupancy Sensor A14291 - Remote Control For Sensor GFCI - GFCI Box <small>[Standard location on back of bollard, consult factory for different location]</small> |
|--|---|

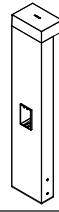

GFCI

More Custom Finishes Available Upon Request

Consult factory for pricing and lead times

MicroPRIM FINISHES

- SW01 - OAK FINISH
- SW02 - WALNUT FINISH
- SW03- PINE FINISH
- DF - DOUGLAS FIR FINISH
- CW - CHERRY WOOD FINISH
- NW - NATIONAL WALNUT FINISH
- SU01 - CONCRETE FINISH
- SU02 - SOFTSCAPE FINISH
- SU03 - STONE FINISH
- SU04 - CORTEN FINISH
- CSM - Custom Image/Pattern

MicroPRIM FINISHES

- MP - MAPLE FINISH
- MHG - MAHOGANY FINISH
- BH - BEECH FINISH
- CN - CHESTNUT FINISH
- WMBL - WHITE MARBLE FINISH
- MBL - MARBLE FINISH
- GRNT - GRANITE FINISH
- BGD - BRUSHED GOLD FINISH
- BBRZ - BRUSHED BRONZE FINISH
- CAMO - CAMOUFLAGE FINISH

- MP01 - MicroPRIM RAL 9011 Black (Glossy)
- MP02 - MicroPRIM RAL 7043 Dark Grey (Glossy)
- MP03 - MicroPRIM RAL 9003 White (Glossy)
- MP04 - MicroPRIM RAL 9006 Metallic Silver (Glossy)
- MP05 - MicroPRIM RAL 9006 Matte Silver (Matte/Textured)
- MP06 - MicroPRIM Ligman Bronze (Glossy)
- MP07 - MicroPRIM Custom Color (Glossy)



MicroPRIM Finish + Two-Tone Style



Prague Product Family



- UPRA-10001-8w-855lm [19.6"]
- UPRA-10002-8w-855lm [39.3"]



- UPRA-10011-14w-1675lm [19.6"]
- UPRA-10012-14w-1675lm [39.3"]



- UPRA-10021-20w-2422lm [19.6"]
- UPRA-10022-20w-2422lm [39.3"]