

# USE-90032

## Steamer Large Round Streetlight



209w LED 28,820 Lm

(For lower Wattages See Page 3)

Weight 35.5 lbs

IP66

Suitable for wet locations

IK08

Impact Resistant [Vandal Resistant]

EPA - 0.070m<sup>2</sup> → 0.753ft<sup>2</sup>

POLE NOT INCLUDED

### Construction

#### Aluminum

Less than 0.1% copper content - Marine Grade 6060 extruded & LM6 Aluminum High Pressure die casting provides excellent mechanical strength, clean detailed product lines and excellent heat dissipation.

#### Pre paint

8 step decrease and phosphate process that includes deoxidizing and etching as well as a zinc and nickel phosphate process before product painting.

#### Memory Retentive -Silicon Gasket

Provided with special injection molded "fit for purpose" long life high temperature memory retentive silicon gaskets. Maintains the gaskets exact profile and seal over years of use and compression.

#### Thermal management

LM6 Aluminum is used for its excellent mechanical strength and thermal dissipation properties in low and high ambient temperatures. The superior thermal heat sink design by Ligman used in conjunction with the driver, controls thermals below critical temperature range to ensure maximum luminous flux output, as well as providing long LED service life and ensuring less than 10% lumen depreciation at 50,000 hours.

#### BUG Rating

B2 - U0 - G2

#### Surge Suppression

Standard 10kv surge suppressor provided with all fixtures.

#### Finishing

All Ligman products go through an extensive finishing process that includes fettling to improve paint adherence.

#### Paint

UV Stabilized 4.9Mil thick powder coat paint and baked at 200 Deg C. This process ensures that Ligman products can withstand harsh environments. Rated for use in natatoriums.

#### MicroPRIM Finishes

MicroPRIM is Ligman's trade marked decorative powder coating technology that permanently infuses colors, patterns, or imagery directly into the surface of luminaires and poles while providing protections that standard powder coating does not offer.

MicroPRIM finishes include nature-inspired wood grains and stone aesthetics, material-inspired finishes such as brushed metal, concrete, and carbon fiber, Solid colors in Ligman standard colors, as well as any RAL or Pantone color, Decorative patterns, custom imagery and more.

#### Coating and Infusion Process

Metal components are pre-treated and powder coated with a proprietary polyurethane-based coating engineered for outdoor architectural use. Decorative patterns or imagery are then permanently infused into the cured powder coat through a heat-based process, creating a durable, integrated finish.

#### Performance and Validation

MicroPRIM finishes are suitable for indoor and outdoor applications and meet AAMA2605 architectural coating requirements. Performance is validated through laboratory and real-world testing to ASTM standards for UV exposure, adhesion, abrasion, impact, salt spray, chemical resistance, and graffiti resistance.

All MicroPRIM finishes are backed by Ligman's 10-year warranty.

#### Key Performance Attributes

- Anti-graffiti resistance
- UV and weather resistance
- Scratch and abrasion resistance
- Natatorium Rated for installation in corrosive environments

#### Hardware

Provided Hardware is Marine grade 316 Stainless steel.

#### Anti Seize Screw Holes

Tapped holes are infused with a special anti seize compound designed to prevent seizure of threaded connections, due to electrolysis from heat, corrosive atmospheres and moisture.

#### Crystal Clear Low Iron Glass Lens

Provided with tempered, impact resistant crystal clear low iron glass ensuring no green glass tinge.

#### Optics & LED

Precise optic design provides exceptional light control and precise distribution of light.  
LED CRI > 80

#### Lumen - Maintenance Life

L80 /B10 at 50,000 hours (This means that at least 90% of the LED still achieve 80% of their original flux)

**Column-mounted contemporary area lighting family. Modern and powerful high-end column range using optimum-quality area lighting projectors.**

A slim, wedge-shaped, high-pressure die-cast pole-mounted area light designed with a full range of distributions to meet the needs of lighting designers in various applications. This luminaire provides outstanding performance through highly efficient LED packages paired with precision-engineered optics, delivering excellent spacing-to-mounting-height ratios and uniform illumination that meets code requirements while reducing energy consumption.

The Steamer can be configured with asymmetrical Type II, III, IV, and ME optical distributions—including customized variations for projects requiring highly specific light patterns. For example, Type II and Type IV optics can be combined within the same fixture to achieve unique distribution requirements.

Type V distributions are also available in narrow, medium, wide, very wide, and extra-wide options; please contact the factory for additional details.





This luminaire meets dark-sky requirements when installed in a level, horizontal orientation. It is ideal for illuminating private roadways, parking areas, exhibition sites, service stations, and truck stops. Optional internal house-side shields are available to further control backlight.

A range of integral electronic and dimmable drivers is offered, along with options for occupancy sensors and wireless lighting controls compatible with building management platforms. (Customer to Specify System)

The fixture features a programmable driver (WATT-ADJUST), allowing factory-set wattage configurations tailored to project specifications.

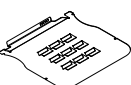
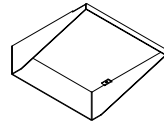
To comply with International Dark Sky Association (IDA) guidelines, the luminaire must be equipped with 3000K (or warmer) LEDs and installed in a fixed horizontal position (±15° allowable for leveling).

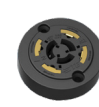
### Additional Options (Consult Factory For Pricing)

 For T1, T2, T3, T5 & ME	 For T4	
<b>IHSS</b> Integrated House Side Shield	<b>EHSS</b> External House Side Shield	
		
<b>A90991</b> Zhaga Book 18	<b>A90891</b> NEMA 7	<b>BD</b> Bird Deterrent Spikes

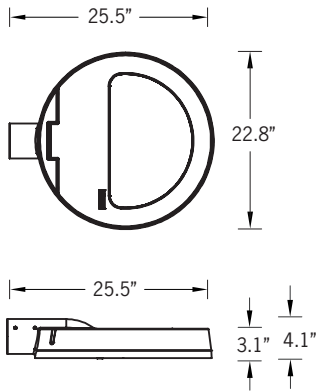

Ligman's micro Variable Optical System provides the ability to interchange, mix & rotate optics to provide specific light distributions for optimized spacing and uniformity.

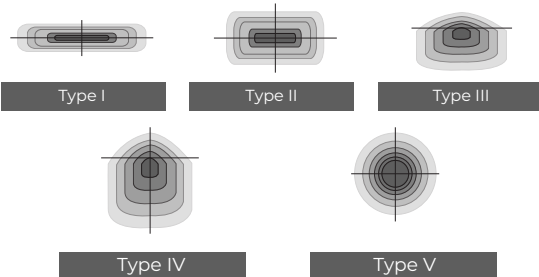

The variable optic system allows for the designer to create hybrid distributions for precise lighting requirements.

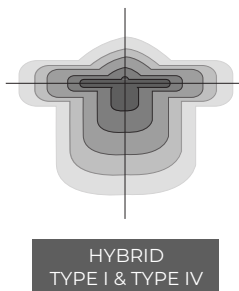

LIGHCONNECT IoT Ready Steamer

# USE-90032

## Steamer Large Round Streetlight



### ACCESSORIES - SINGLE HEAD

Tenon Mount  
Without decorative  
back post  
L Shape, Large Head  
A91060-L-L - 2.36" Tenon  
A91076-L-L - 2.99" Tenon



With decorative back post  
T Shape, Large Head  
A91060-T-L - 2.36" Tenon  
A91076-T-L - 2.99" Tenon



Tenon Mount  
Without decorative  
back post  
L Shape, Large Head  
A91260-L-L - 2.36" Tenon  
A91276-L-L - 2.99" Tenon



With decorative back post  
T Shape, Large Head  
A91260-T-L - 2.36" Tenon  
A91276-T-L - 2.99" Tenon



Tenon Mount  
Without decorative  
back post  
L Shape, Large Head  
A91660-L-L - 2.36" Tenon  
A91676-L-L - 2.99" Tenon

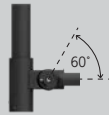

With decorative back post  
T Shape, Large Head  
A91660-T-L - 2.36" Tenon  
A91676-T-L - 2.99" Tenon

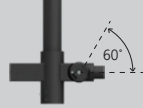

A91460 - 2.36" Tenon  
A91476 - 2.99" Tenon  
EPA: 1.85ft<sup>2</sup>

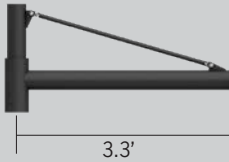

EA  
EPA: 2.38 ft<sup>2</sup>

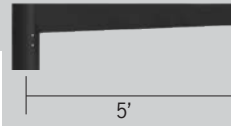

GA  
EPA: 2.38ft<sup>2</sup>

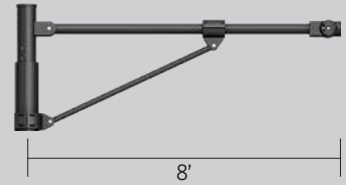

### ACCESSORIES - DOUBLE HEAD



A91160 - 2.36" Tenon  
A91176 - 2.99" Tenon  
EPA: 0.71ft<sup>2</sup>



A91360 - 2.36" Tenon  
A91376 - 2.99" Tenon  
EPA: 0.95ft<sup>2</sup>

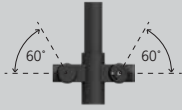

A91760 - 2.36" Tenon  
A91776 - 2.99" Tenon  
EPA: 0.97ft<sup>2</sup>

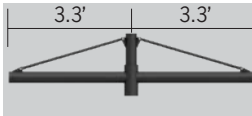

A91560 - 2.36" Tenon  
A91576 - 2.99" Tenon  
EPA: 2.88ft<sup>2</sup>



EA2  
EPA: 4.76 ft<sup>2</sup>



GA2  
EPA: 4.26ft<sup>2</sup>

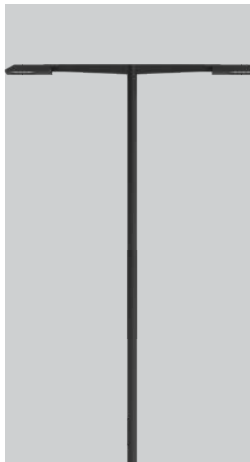

### ACCESSORIES - TRIPLE HEAD

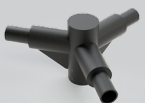

A92260 - 2.36" Tenon  
A92276 - 2.99" Tenon



A92360 - 2.36" Tenon  
A92376 - 2.99" Tenon

# USE-90032

## Steamer Large Round Streetlight



PROJECT		DATE	
---------	--	------	--

QUANTITY		TYPE		NOTE	
----------	--	------	--	------	--

ORDERING EXAMPLE || USE-90032 - 209w - T2 - W30 - 02 - 120/277v

USE-90032					
LAMP	BEAM	LED COLOR	FINISH COLOR	VOLTAGE	
209w LED - 28,820lm 157w LED - 21,666lm 120w LED - 16,560lm 80w LED - 11,040lm 29w LED - 4,002lm <b>WATT-ADJUST</b> (Factory programmed to specific wattage)	T1 - Type I Distribution T2 - Type II Distribution T3 - Type III Distribution T4 - Type IV Distribution ME - Type ME Distribution N - Narrow Beam 12° M - Medium Beam 30° W - Wide Beam 57° EW - Extra Wide Beam 119° x 86°	W27 - 2700K W30 - 3000K W35 - 3500K W40 - 4000K AMB - <b>TURTLE FRIENDLY</b> Amber LED	01 - BLACK RAL 9011 02 - DARK GREY RAL 7043 03 - WHITE RAL 9003 04 - METALLIC SILVER RAL 9006 05 - MATTE SILVER RAL 9006 06 - LIGMAN BRONZE 07 - CUSTOM RAL	120/277v	

--	--	--	--

**POLE TOP ACCESSORIES**  
[ See Page 2 ]

**ADDITIONAL OPTIONS - CONSULT FACTORY FOR PRICING**

- |                                   |   |
|-----------------------------------|---|
| DIM - 0-10v Dimming               | A90991-U - Zhaga Book 18 Mounted On Top of Fixture        |
| BD - Bird Deterrent Spikes        | A90991-D - Zhaga Book 18 Mounted Below Fixture            |
| F - Frosted Lens                  | A90891 - NEMA 7   |
| IHSS - Internal House Side Shield | OS - FSP Occupancy Sensor [See last page]                 |
| EHSS - External House Side Shield | FSIR - Occupancy Sensor Remote Programmer [See last page] |

### More Custom Finishes Available Upon Request

Consult factory for pricing and lead times

#### MicroPRIM FINISHES

- SW01 - OAK FINISH
- SW02 - WALNUT FINISH
- SW03- PINE FINISH
- DF - DOUGLAS FIR FINISH
- CW - CHERRY WOOD FINISH
- NW - NATIONAL WALNUT FINISH
- SU01 - CONCRETE FINISH
- SU02 - SOFTSCAPE FINISH
- SU03 - STONE FINISH
- SU04 - CORTEN FINISH
- CSM - Custom Image/Pattern

#### MicroPRIM FINISHES

- MP - MAPLE FINISH
- MHG - MAHOGANY FINISH
- BH - BEECH FINISH
- CN - CHESTNUT FINISH
- WMBL - WHITE MARBLE FINISH
- MBL - MARBLE FINISH
- GRNT - GRANITE FINISH
- BGD - BRUSHED GOLD FINISH
- BBRZ - BRUSHED BRONZE FINISH
- CAMO - CAMOUFLAGE FINISH

- MP01 - MicroPRIM RAL 9011 Black (Glossy)
- MP02 - MicroPRIM RAL 7043 Dark Grey (Glossy)
- MP03 - MicroPRIM RAL 9003 White (Glossy)
- MP04 - MicroPRIM RAL 9006 Metallic Silver (Glossy)
- MP05 - MicroPRIM RAL 9006 Matte Silver (Matte/Textured)
- MP06 - MicroPRIM Ligman Bronze (Glossy)
- MP07 - MicroPRIM Custom Color (Glossy)



MicroPRIM Finish



# HIGH/LOW/OFF PIR OUTDOOR PHOTO/MOTION SENSOR IP66 - **legrand**® Integrated photocell

Ligman provides integrated photocell control using the wattstopper legrand FSP-211B. These units are installed inside the fixture housing with only the external lenses being visible



FSP-211B

## Dimensions of Lens Options

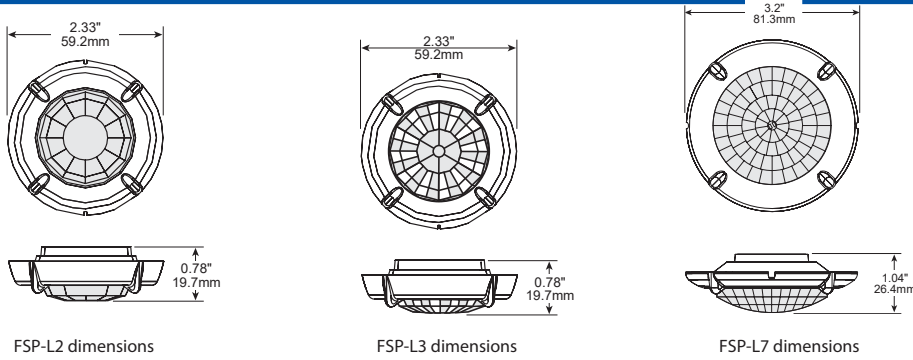

## Product Overview

The FSP-221B is a family of passive infrared (PIR) outdoor sensors that raise or lower the electric lighting level to high, low or off based on motion and/or daylight contribution. Typically, once the sensor stops detecting movement and the time delay elapses, lights will first fade to low mode, and eventually switch off. When motion is detected, the sensor ramps the light level to high mode unless the daylight contribution is sufficient.

The integral photocell can also switch the lights on and off for dusk to dawn control, so that lighting remains on overnight even without motion detection.

The sensors control 0-10VDC or nondimming LED drivers or ballasts.

The low voltage FSP-201B may be used with dim-to-off drivers or ballasts.

Initial setup and subsequent sensor adjustments are made using a Wireless Handheld Configuration Tool (FSIR-100). This tool enables adjustment of sensor parameters including high/low mode, sensitivity, time delay, cut off and more.

The FSIR-100 can read current parameter settings, and stores up to six sensor parameter profiles to speed commissioning of multiple sensors.

## Coverage

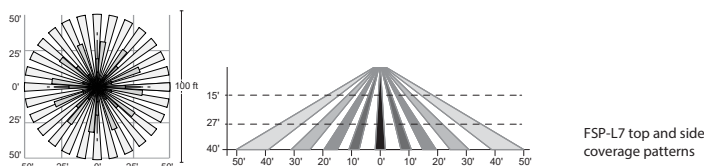
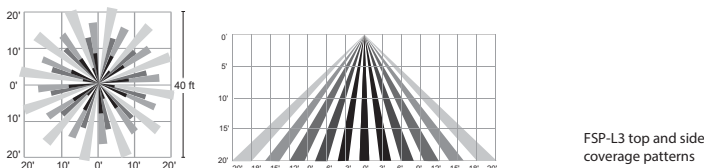
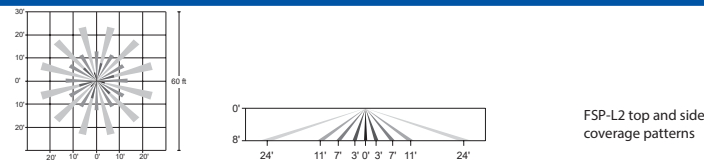

## Models

FSP-211B, 120-277 VAC  
FSP-221B, 100-347 VAC

## Specifications and Features

- Three interchangeable lenses for mounting between 8' and 40'
- Remote setup and adjustment with handheld wireless configuration tool
- Adjustable high and low modes (high: 0 to 10V, low: off, 0 to 9.8V)
- Adjustable time delay (30 seconds, 1 to 30 minutes)
- Adjustable cut off delay (none, 1 to 59 minutes, 1 to 5 hours)
- Adjustable sensitivity/service mode (low, med, max; on-fix, off-fix)
- Adjustable setpoints: hold off setpoint (none, 1 to 250 fc, auto); photocell on/off setpoint (1 to 250 fc)
- Adjustable ramp and fade times (1 to 60 seconds)
- Operating temperature: -40°F to +167°F (-40°C to +75°C)
- IP66 rated
- Five year warranty

## Factory Defaults

High mode:	10V
Low mode:	1V
Time delay:	5 minutes
Cut off:	1 hour
Setpoint:	Disabled
Sensitivity:	Max
Ramp up time:	Disabled
Fade down time:	Disabled
Photocell On/Off:	Disabled

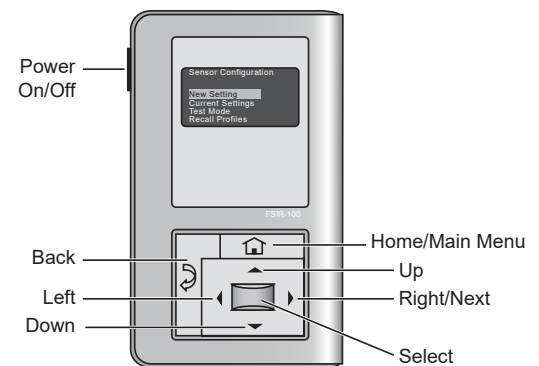

The FSIR-100 is a convenient handheld remote tool for sensor setting. Adjustable settings can be changed as needed for specific applications.

Catalog #	Color	Description
FSP-L2	White/Grey/Black/Brown <small>The Trim color option will be selected to closest match fixture color. e.g. (Matte silver fixture - grey trim)</small>	360° lens, maximum coverage 48' diameter from 8' height
FSP-L3	White/Grey/Black/Brown <small>The Trim color option will be selected to closest match fixture color. e.g. (Matte silver fixture - grey trim)</small>	360° lens, maximum coverage 40' diameter from 20' height
FSP-L7	White/Grey/Black/Brown <small>The Trim color option will be selected to closest match fixture color. e.g. (Matte silver fixture - grey trim)</small>	360° lens, maximum coverage 100' diameter from 40' height
FSIR-100	Black	Remote Handheld Configuration Tool