

ULEW-30001

Leeds 1 Small Surface Wedge Downlight



Construction

Aluminum

Less than 0.1% copper content - Marine Grade 6060 extruded & LM6 Aluminum High Pressure die casting provides excellent mechanical strength, clean detailed product lines and excellent heat dissipation.

Pre paint

8 step degrease and phosphate process that includes deoxidizing and etching as well as a zinc and nickel phosphate process before product painting.

Memory Retentive -Silicon Gasket

Provided with special injection molded "fit for purpose" long life high temperature memory retentive silicon gaskets. Maintains the gaskets exact profile and seal over years of use and compression.

Thermal management

LM6 Aluminum is used for its excellent mechanical strength and thermal dissipation properties in low and high ambient temperatures. The superior thermal heat sink design by Ligman used in conjunction with the driver, controls thermals below critical temperature range to ensure maximum luminous flux output, as well as providing long LED service life and ensuring less than 10% lumen depreciation at 50,000 hours.

Surge Suppression

Standard 10kv surge suppressor provided with all fixtures.

BUG Rating

B0 - U0 - G0 (T1, T2, T3, T4, ME)
B1 - U0 - G0 (M, W, EW)

Finishing

All Ligman products go through an extensive finishing process that includes fettling to improve paint adherence.

Paint

UV Stabilized 4.9Mil thick powder coat paint and baked at 200 Deg C. This process ensures that Ligman products can withstand harsh environments. Rated for use in natatoriums.

MicroPRIM Finishes

MicroPRIM is Ligman's trade marked decorative powder coating technology that permanently infuses colors, patterns, or imagery directly into the surface of luminaires and poles while providing protections that standard powder coating does not offer.

MicroPRIM finishes include nature-inspired wood grains and stone aesthetics, material-inspired finishes such as brushed metal, concrete, and carbon fiber, Solid colors in Ligman standard colors, as well as any RAL or Pantone color, Decorative patterns, custom imagery and more.

Coating and Infusion Process

Metal components are pre-treated and powder coated with a proprietary polyurethane-based coating engineered for outdoor architectural use. Decorative patterns or imagery are then permanently infused into the cured powder coat through a heat-based process, creating a durable, integrated finish.

Performance and Validation

MicroPRIM finishes are suitable for indoor and outdoor applications and meet AAMA2605 architectural coating requirements. Performance is validated through laboratory and real-world testing to ASTM standards for UV exposure, adhesion, abrasion, impact, salt spray, chemical resistance, and graffiti resistance.

All MicroPRIM finishes are backed by Ligman's 10-year warranty.

Key Performance Attributes

- Anti-graffiti resistance
- UV and weather resistance
- Scratch and abrasion resistance
- Natatorium Rated for installation in corrosive environments)

Hardware

Provided Hardware is Marine grade 316 Stainless steel.

Anti Seize Screw Holes

Tapped holes are infused with a special anti seize compound designed to prevent seizure of threaded connections, due to electrolysis from heat, corrosive atmospheres and moisture.

Crystal Clear Low Iron Glass Lens

Provided with tempered, impact resistant crystal clear low iron glass ensuring no green glass tinge.

Optics & LED

Precise optic design provides exceptional light control and precise distribution of light. LED CRI > 80

Lumen - Maintenance Life

L80 /B10 at 50,000 hours (This means that at least 90% of the LED still achieve 80% of their original flux)

Clean, beautiful, surface wall fixtures with class leading performance. Minimalist form, yet the most powerful and flexible lighting tool of its type, offering packages up to 2,400 lumens and microVos technology.

A range of small, square and rectangular, ADA compliant wall mounted luminaires with options of upward or downward light distributions. Ideally suited to illuminate the wall and surfaces in front of wall and for light accents on vertical surfaces using high efficiency LED's. The Leeds is suitable for indoor and outdoor applications and provides a clean, visually appealing solution for small, unobtrusive wall mounted luminaires.

This luminaire is available in 3 different sizes and in combinations of down, up or up/down light distributions.

This fixture utilizes microVos technology, meaning the ability to do Type I,II,III,IV & V distributions as well as hybrid distributions to suit the designer's requirements.

Using the microVos optics allows for very wide spacing to mounting height ratios, while still providing perfect uniformity and code compliant light levels.

To meet International Dark Sky criteria, 3000k or warmer LEDs must be selected and luminaire fix mounted (+/- 15° allowable to permit leveling).

Additional Options (Consult Factory For Pricing)

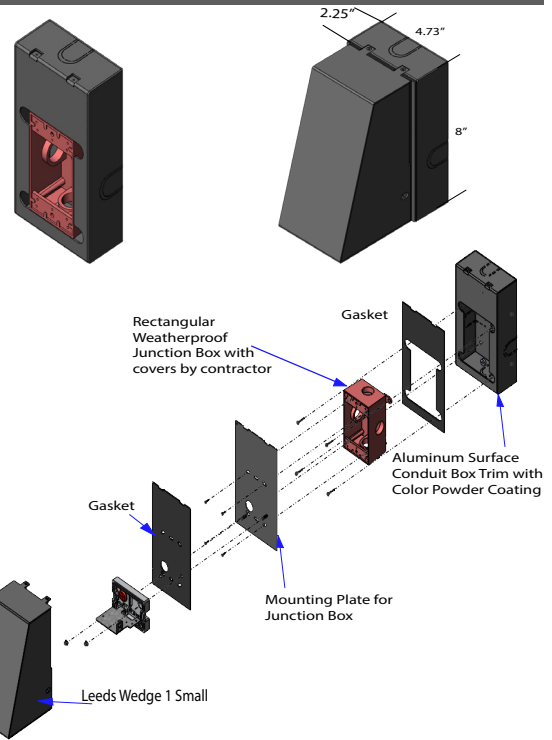

SCBT
Surface Conduit Box Trim

NOTE: This trim covers a shallow single gang, surface mount junction box [Provided by contractor]
Example: Hubbell - 5322-0 - 1-Gang Weatherproof Box, Five 1/2" in. Threaded Outlets - or - 5332-0 - 1-Gang Weatherproof Box, Five 3/4 in. Threaded Outlets

5.5w LED 627 Lumens
IP65 - Suitable For Wet Locations
IK07 - Impact Resistant
Weight 5 lbs

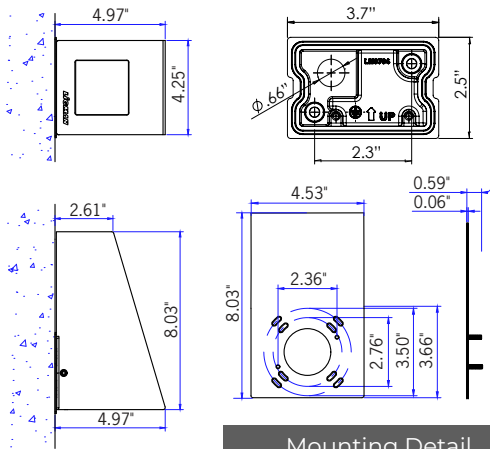

Mounting Detail



Ligman's micro Variable Optical System provides the ability to interchange, mix & rotate optics to provide specific light distributions for optimized spacing and uniformity.

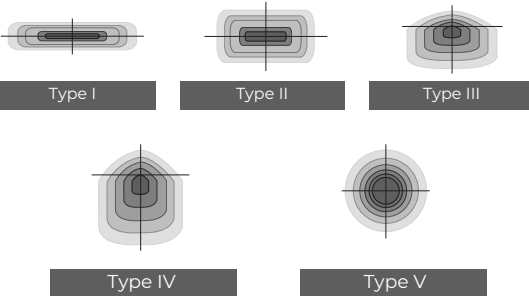

ULEW-30001

Leeds 1 Small Surface Downlight



PROJECT		DATE	
---------	--	------	--

QUANTITY		TYPE		NOTE	
----------	--	------	--	------	--

ORDERING EXAMPLE || ULEW - 30001 - 5.5w - T2 - W30 - 02 - 120/277v - Options

ULEW-30001					
LAMP	BEAM	LED COLOR	FINISH COLOR	VOLTAGE	
5.5w LED 627 Lumens	T1 - Type I Distribution T2 - Type II Distribution T3 - Type III Distribution T4 - Type IV Distribution M - Medium 30° W - Wide 56° EW - Extra Wide 99° x102°	W27 - 2700K W30 - 3000K W35 - 3500K W40 - 4000K AMB - TURTLE FRIENDLY Amber LED	01 - BLACK RAL 9011 02 - DARK GREY RAL 7043 03 - WHITE RAL 9003 04 - METALLIC SILVER RAL 9006 05 - MATTE SILVER RAL 9006 06 - LIGMAN BRONZE 07 - CUSTOM RAL	120/277v	

--	--	--

ADDITIONAL OPTIONS

- NAT - Natatorium Rated
- F - Frosted Lens
- BPC - Button Photocell
- SCBT - Surface Conduit Box Trim

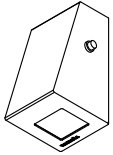

BPC
Button Photocell

More Custom Finishes Available Upon Request

Consult factory for pricing and lead times

THERE IS AN ADDITIONAL COST FOR THESE FINISHES

MicroPRIM FINISHES

- SW01 - OAK FINISH
- SW02 - WALNUT FINISH
- SW03- PINE FINISH
- DF - DOUGLAS FIR FINISH
- CW - CHERRY WOOD FINISH
- NW - NATIONAL WALNUT FINISH
- SU01 - CONCRETE FINISH
- SU02 - SOFTSCAPE FINISH
- SU03 - STONE FINISH
- SU04 - CORTEN FINISH
- CSM - Custom Image/Pattern

MicroPRIM FINISHES

- MP - MAPLE FINISH
- MHG - MAHOGANY FINISH
- BH - BEECH FINISH
- CN - CHESTNUT FINISH
- WMBL - WHITE MARBLE FINISH
- MBL - MARBLE FINISH
- GRNT - GRANITE FINISH
- BGD - BRUSHED GOLD FINISH
- BBRZ - BRUSHED BRONZE FINISH
- CAMO - CAMOUFLAGE FINISH

- MP01 - MicroPRIM RAL 9011 Black (Glossy)
- MP02 - MicroPRIM RAL 7043 Dark Grey (Glossy)
- MP03 - MicroPRIM RAL 9003 White (Glossy)
- MP04 - MicroPRIM RAL 9006 Metallic Silver (Glossy)
- MP05 - MicroPRIM RAL 9006 Matte Silver (Matte/Textured)
- MP06 - MicroPRIM Ligman Bronze (Glossy)
- MP07 - MicroPRIM Custom Color (Glossy)



MicroPRIM Finish



Leeds Product Family



Leeds 1 - Up/Down

· ULEE-30031-2x5.5w-2x570lm



Leeds 2 - Down

· ULEE-30001-5.5w-570lm



Leeds 3 - Up/Down

· ULEE-30041-2x14w-2x1660lm



Leeds 4 - Down

· ULEE-30011-14w-1660lm



Leeds 5 - Up/Down

· ULD-30051-2x20w-2x2422lm



Leeds 6 - Down

· ULEE-30021-20w-2422lm

Leeds Wedge Product Family



Leeds Wedge 1

· ULEW-30001-5.5w-570lm



Leeds Wedge 2

· ULEW-30011-14w-1660lm



Leeds Wedge 3

· ULEW-30021-20w-2422lm

Type II Distribution

Type III Distribution

Type IV Distribution

Type ME Distribution

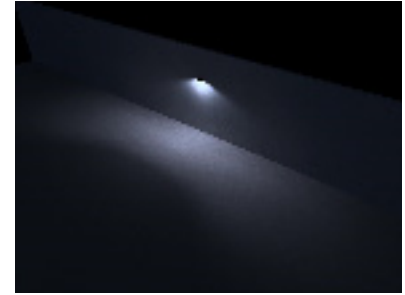
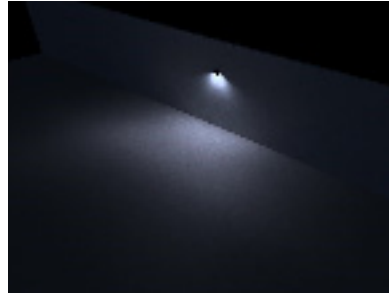
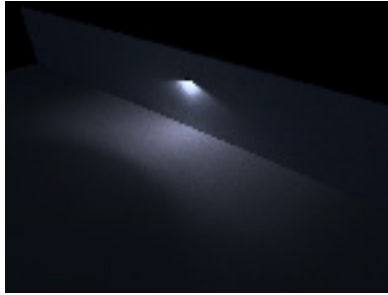
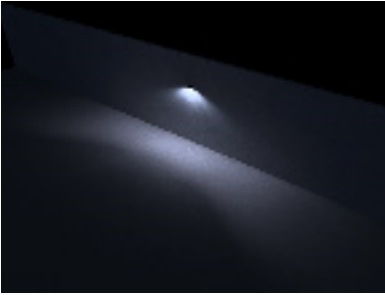
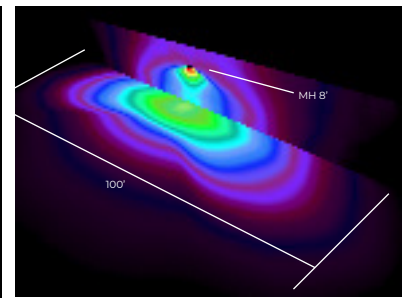
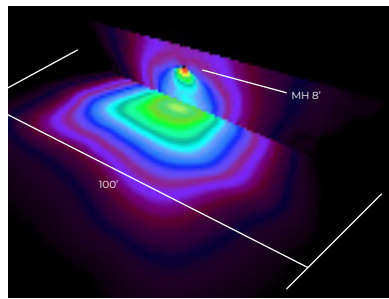
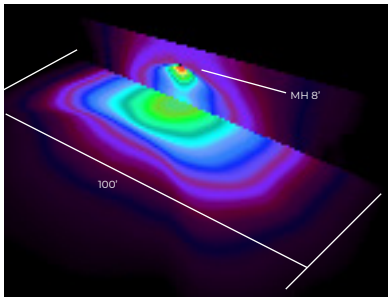
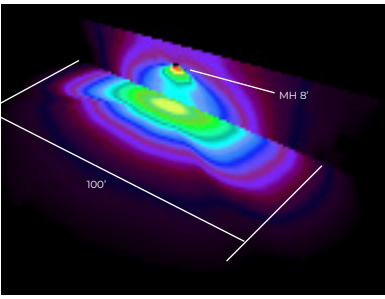

Medium Beam - 30°

Wide Beam - 56°

Extra Wide Beam - 99° x 102°

